

V lower undersink unit kit high | medium | low version

Kit sottolavello inferiore V versione alta | media | bassa

Sottolavelli | Undersink units

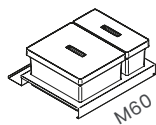

28 high | 25 medium | 21 low

KSIVSC06028MP/MA
KSIVSC06025MP/MA
KSIVSC06021MP/MA

KSIVLEA06028MP/MA
KSIVLEA06025MP/MA
KSIVLEA06021MP/MA

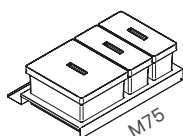

28 high | 25 medium | 21 low

KSIVSC07528MP/MA
KSIVSC07525MP/MA
KSIVSC07521MP/MA

KSIVLEA07528MP/MA
KSIVLEA07525MP/MA
KSIVLEA07521MP/MA

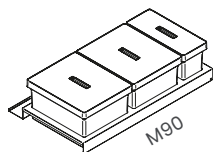

28 high | 25 medium | 21 low

KSIVSC09028MP/MA
KSIVSC09025MP/MA
KSIVSC09021MP/MA

KSIVLEA09028MP/MA
KSIVLEA09025MP/MA
KSIVLEA09021MP/MA

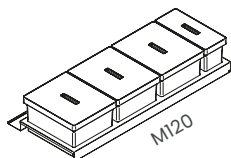

28 high | 25 medium | 21 low

KSIVSC12028MP/MA
KSIVSC12025MP/MA
KSIVSC12021MP/MA

KSIVLEA12028MP/MA
KSIVLEA12025MP/MA
KSIVLEA12021MP/MA

Warnings

1. Leggi attentamente le istruzioni prima del montaggio e segui ogni passaggio indicato. L'azienda declina ogni responsabilità nel caso di mancato rispetto delle indicazioni riportate sulle istruzioni montaggio. L'azienda declina ogni responsabilità per l'uso improprio del prodotto.
2. Questo prodotto NON è una scala. Ogni uso improprio del prodotto può causare lesioni. Modifiche o manomissioni del prodotto, annullano ogni condizione di garanzia.
3. Questo prodotto contiene piccole parti. Rischio di soffocamento. Tenere fuori dalla portata dei bambini. In caso di malfunzionamento, interrompere l'uso e contattare l'Assistenza Tecnica autorizzata.
4. Smaltisci i diversi materiali secondo le regolamentazioni della tua città.

1. Please read the instructions carefully before assembly and follow each step indicated. The company declines all responsibility in case of non-compliance with the instructions provided for assembly. The company is not responsible for improper use of the product.
2. This product is NOT a ladder. Any improper use of the product may cause injury. Modifications or tampering with the product voids any warranty conditions.
3. This product contains small parts. Choking hazard. Keep out of reach of children. In case of malfunction, stop using the product and contact authorized Technical Support.
4. Proceed to dispose of the different materials according to your city regulations.

Attention!

1. Rinforcare il fondo del mobile con un piedino aggiuntivo se necessario.
2. Verificare la messa in bolla del mobile.
3. Fissare il mobile a parete.

1. The bottom of the cabinet could be reinforced with additional legs if necessary.
2. The levelling of the cabinet must be verified.
3. The cabinet must be fixed to the wall.

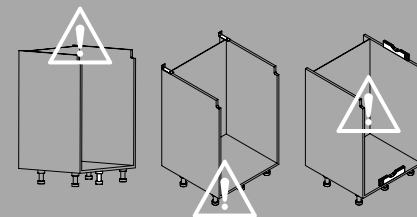
**Maintenance**

Inquadrate il codice QR per scoprire la corretta manutenzione del prodotto.

Scan the QR code to discover the correct maintenance of the product.



x 1



mm



3 min.

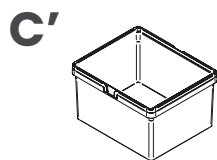

bassa | low version

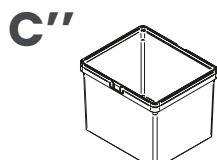

alta | high version

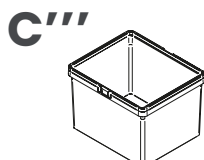

media | medium version

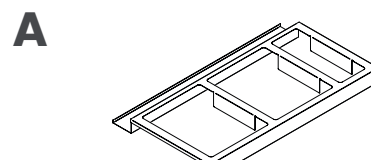

x 1

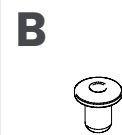

x 3

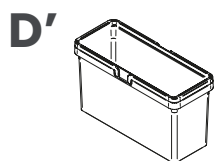

bassa | low version

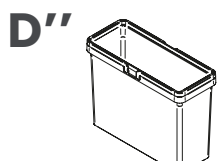

alta | high version

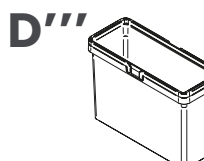

media | medium version

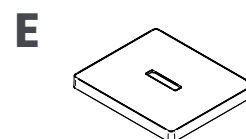
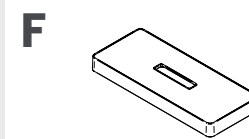
acciaio | stainless steel
plastica | plasticacciaio | stainless steel
plastica | plastic

x 3

2 filtri di ricambio | 2 replacement filters
Filtro a carbone attivo | Activated carbon filter



x 1

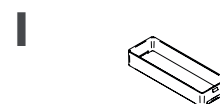

I

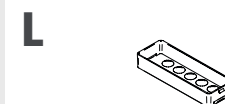

L

x 1

	C'	C''	C'''	D'	D''	D'''	E	F	I	L
M60	x1	x1	x1	x1	x1	x1	x1	x1	x1	x1
M75	x1	x1	x1	x2	x2	x2	x1	x2	x2	x1
M90	x2	x2	x2	x1	x1	x1	x2	x1	x2	x1
M120	x3	x3	x3	x1	x1	x1	x3	x1	x3	x1

Litraggio Bin's capacity L Lt			
C'	23 L	D'	11 L
C''	30 L	D''	15 L
C'''	27 L	D'''	13 L

1.

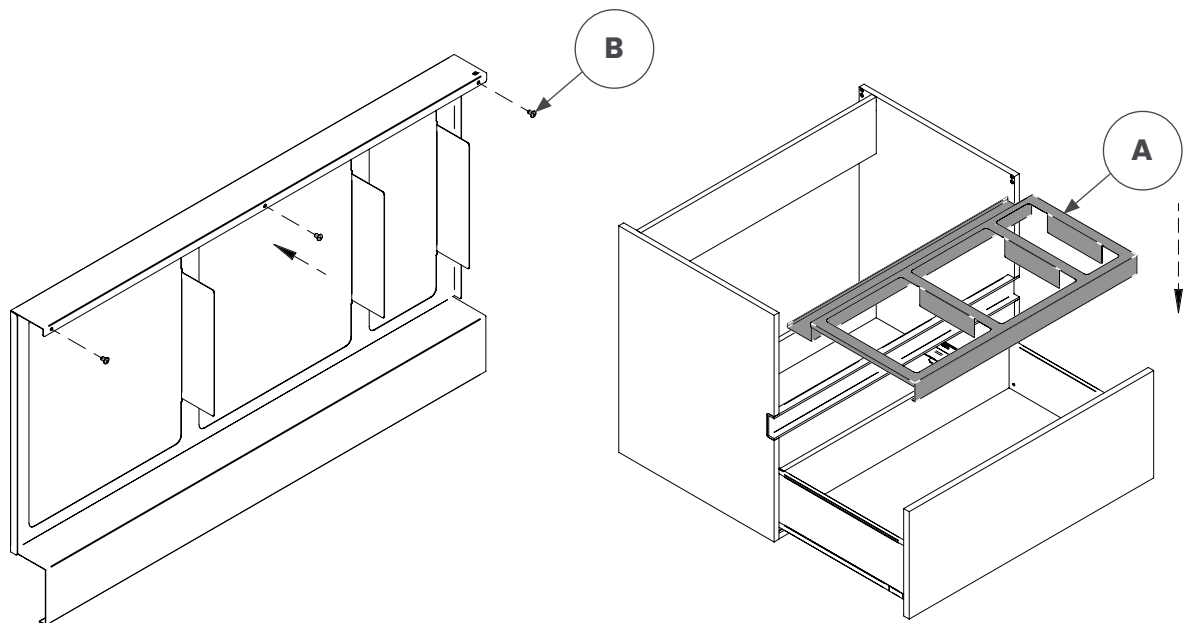
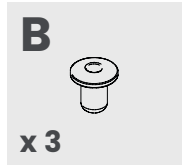
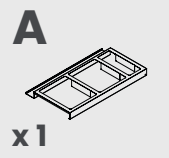

2a. Pattumiere C' / C'' / C''' | Bins C' / C'' / C'''

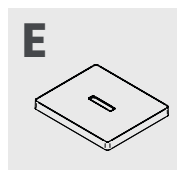
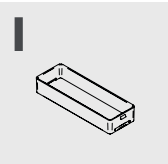
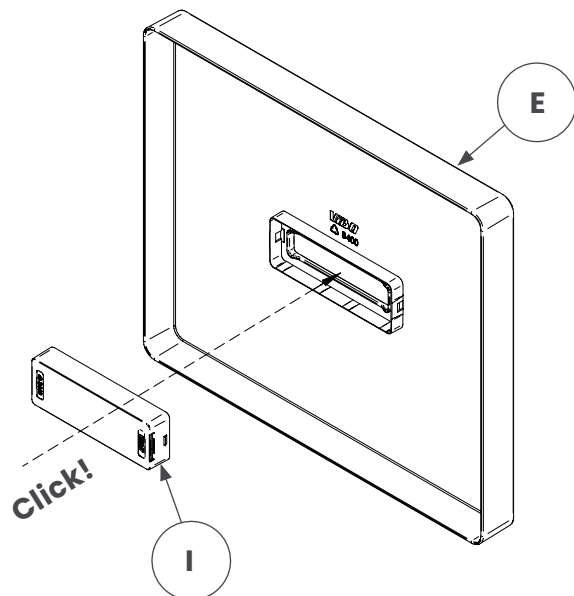

2b. Pattumiere D' / D'' / D''' | Bins D' / D'' / D'''

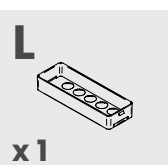
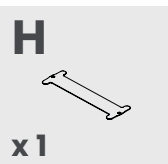
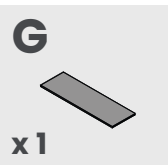
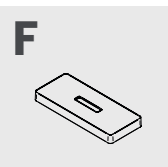
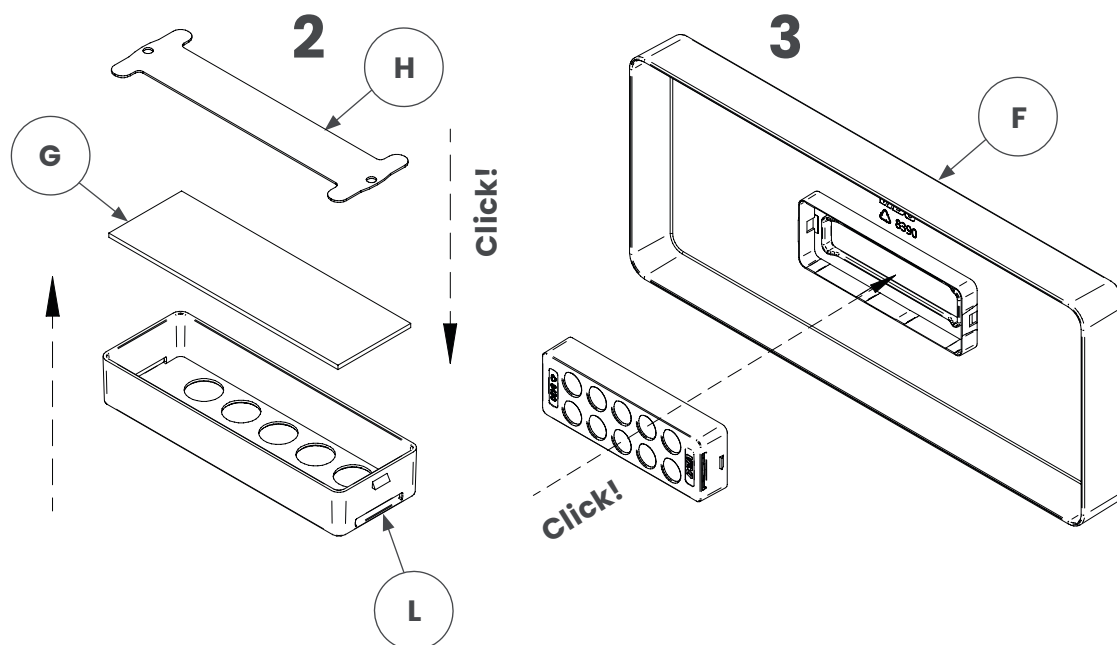

3.

