

V lower undersink unit kit | Medium version

Kit sottolavello inferiore V | versione media

Sottolavelli inferiori | Lower undersink units

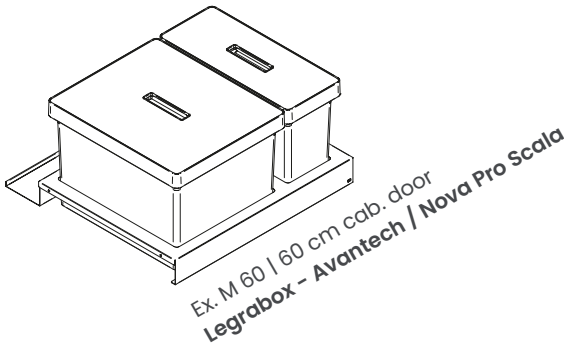

Materials

Struttura Structure

Lamiera Sheet metal

Coperchi Lids

Plastica Polypropylene

Acciaio Stainless steel

Contenitori Bins

Plastica Polypropylene

Cat. code

KSIVLEA06025MA

KSIV	Nome Name
LEA	Spondine Sides
060	Modulo Cab. door
25	Altezza Height
M	Manuale Manual
A	Materiale Lid's material

Available finishes

VGf | VNF

Verniciato Grigio Antracite
Epoxy-coated Grigio Antracite

Verniciato Nero Freddo
Epoxy-coated Flat Black

GF | NM Contenitori Bins

Grigio Antracite
Nero Materico

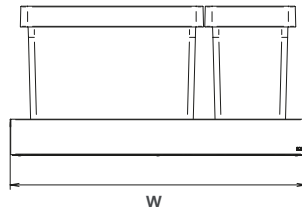
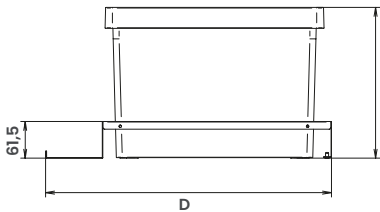

Litraggio | Bins' capacity

NA* Non disponibile al momento Not available at the moment Unità Unit of measurement mm

Maintenance and disposal

Il corretto smaltimento dell'imballaggio e la manutenzione del prodotto sono importanti per noi. Scansiona il codice QR per maggiori informazioni

Proper packaging disposal and product maintenance are important to us. Scan the QR code for more information



Instruction sheet

4004110611MKT

Description

Kit sottolavello inferiore V - versione media - caratterizzato da un basamento in lamiera zincata e verniciata e progettato per essere appoggiato direttamente sul fondo del cassetto. Abbinato a coperchi manuali rimovibili in acciaio anti-impronta o in plastica. Nella parte posteriore include un vano portadetersivi, pensato per ottimizzare lo spazio. Sezione dedicata all'umido con filtro a carboni attivi, antiodore e lavabile di serie.

The V lower undersink kit - medium version - features a pre-galvanized and epoxy-coated sheet metal, designed to be placed directly on the drawer bottom. It comes with manually removable anti-fingerprint stainless steel or plastic lids. Integrated rear detergent compartment to optimize the space. Organic waste section with odor-resistant, washable, activated carbon filter as standard.

Dimensions

Cat. code • Legrabox - Avantech	Width	Depth	Height
KSIVLEA06025MA MP	515	472	253
KSIVLEA07525MA MP	665	472	253
KSIVLEA09025MA MP	815	472	253
KSIVLEA12025MA MP	1115	472	253

Packaging

Size	Weight (kg)
530 x 510 x 305	5,7
680 x 505 x 315	7,2
830 x 505 x 310	8,4
1135 x 505 x 315	11,2

Plt configuration

Size	Pieces
1200 x 800	14
1200 x 800	12
1200 x 800	7
1200 x 800	6

Cat. code • Nova Pro Scala	Width	Depth	Height
KSIVSC06025MA MP	500	479	253
KSIVSC07525MA MP	650	479	253
KSIVSC09025MA MP	800	479	253
KSIVSC12025MA MP	1100	479	253

Size	Weight (kg)
530 x 510 x 305	5,7
680 x 505 x 315	7,2
830 x 505 x 310	8,4
1135 x 505 x 315	11,2

Size	Pieces
1200 x 800	14
1200 x 800	12
1200 x 800	7
1200 x 800	6

A = coperchio in acciaio anti-impronta | anti-fingerprint stainless steel lids P = coperchio in plastica | plastic lids



Vibo S.p.A Via Arzignano, 46 36070
Trissino VI - Italy | Tel +39 0445 492800
vibo@viboitaly.com | viboitaly.com

*Le informazioni contenute nelle presenti schede tecniche sono indicative. Eventuali differenze con il listino in vigore non costituiscono motivo di contestazione. The information given in this technical sheet are indicative. Any discrepancies with the price list currently in force cannot be cause for complaint.

Legrabox - AvanTech

M 60 | Cab. door

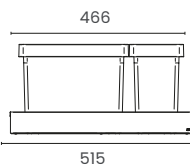
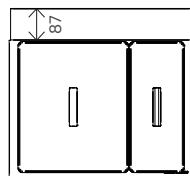

KSIVLEA06025MP
KSIVLEA06025MA
27 + 13 L

M 75 | Cab. door

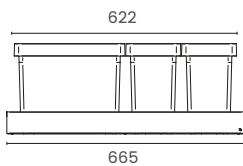
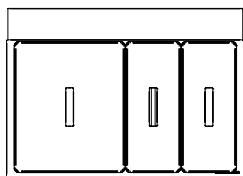

KSIVLEA07525MP
KSIVLEA07525MA
27 + 13 + 13 L

M 90 | Cab. door

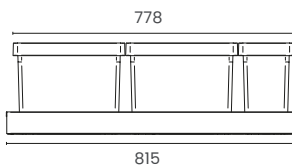
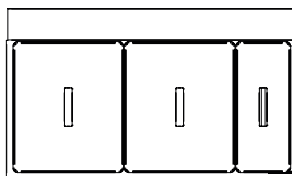

KSIVLEA09025MP
KSIVLEA09025MA
27 + 27 + 13 L

M 120 | Cab. door

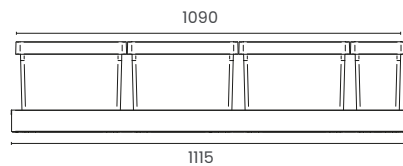
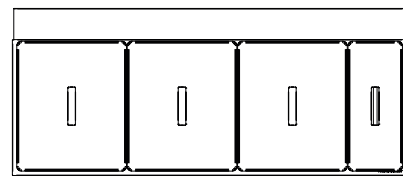

KSIVLEA12025MP
KSIVLEA12025MA
27 + 27 + 27 + 13 L

Nova Pro Scala

M 60 | Cab. door

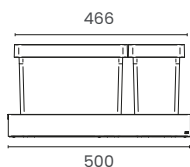
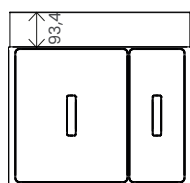

KSIVSC06025MP
KSIVSC06025MA
27 + 13 L

M 75 | Cab. door

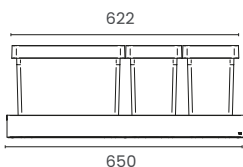
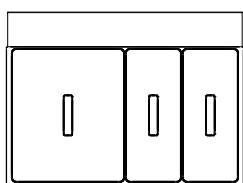

KSIVSC07525MP
KSIVSC07525MA
27 + 13 + 13 L

M 90 | Cab. door

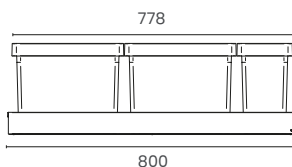
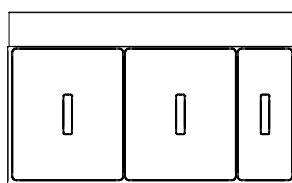

KSIVSC09025MP
KSIVSC09025MA
27 + 27 + 13 L

M 120 | Cab. door

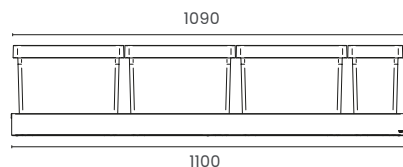
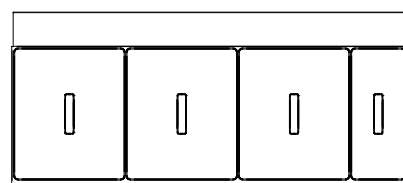

KSIVSC12025MP
KSIVSC12025MA
27 + 27 + 27 + 13 L